

# WT-X22

## Voice Prompter (WiFi Version)



### 1. Product introduction

Welcome to use Waytronic products, this product adopts motion induction technology, when a person passes through the induction area, it will immediately broadcast the voice. The product uses a WIFI module, connects to the WiFi network and server to realize central control management, with grouping, voice change, timing, playing mode change function, it also support replace the voice by USB cable connect with computer. The appearance and operation is simple and convenient. It is widely used in chain stores, supermarkets, shopping malls and other places.

## 2. Electrical parameters

Power supply mode	DC5V 1A	
Working Current	Sleep standby mode	≤130mA
	Playing mode	≤450mA
Audio Format	MP3	Bit Rate: 16~320Kbps
Audio Output	8Ω/2W(typical value)	
Volume	≥100dB	
Infrared Induction Range	≥4 meters	
Operating Temperature	-20-33℃	

## 3. Appearance introduction

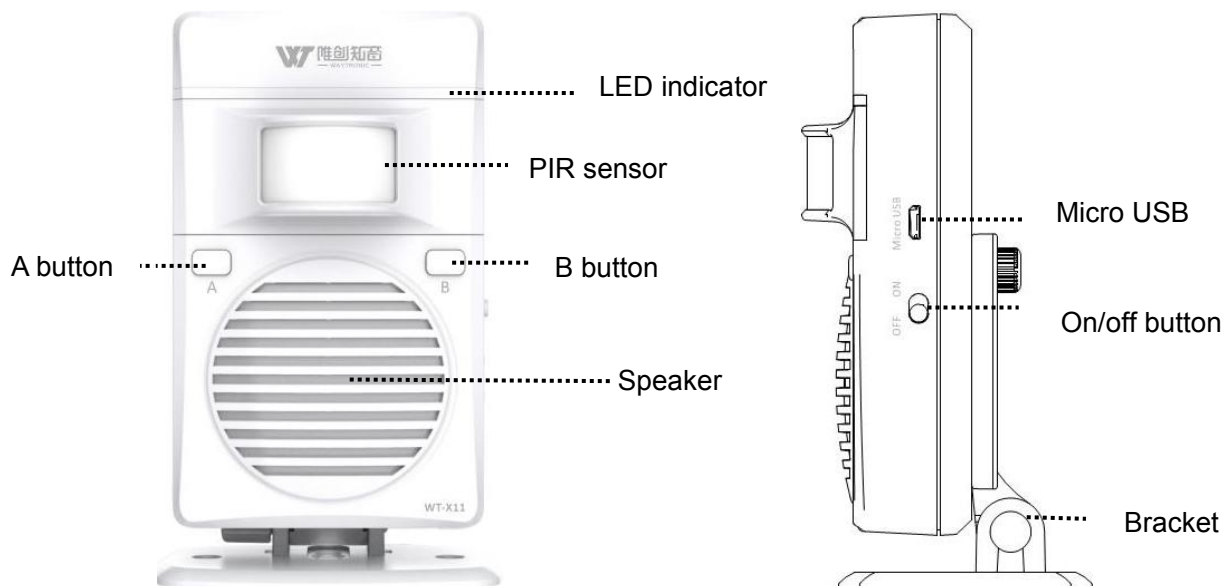

### 3.1 Button function

Button name	Operation	Function
On-off button	Switch	Turn on/off
A button	Short press	Next audio (all loop)
	Long press 3 seconds	Single playing mode (Red light flashes 3 times)
B button	Short press	Volume adjust (1-8 level)
	Long press 3 seconds	All loop playing mode (Red light flashes 3 times)

### 3.2 LED function

LED color	function	Working condition
Red	Playing	Red LED on when playing, off when finish playing
Blue	WiFi did not connect	The blue LED keeps on
	WiFi connected	The blue LED flashes
	Audio update	The blue LED flashes in a fast speed

## 4. Audio update by USB cable

Use USB cable connected with computer and followed the instruction to named the audio file

## 5. Installation

### 5.1 Bracket assembly

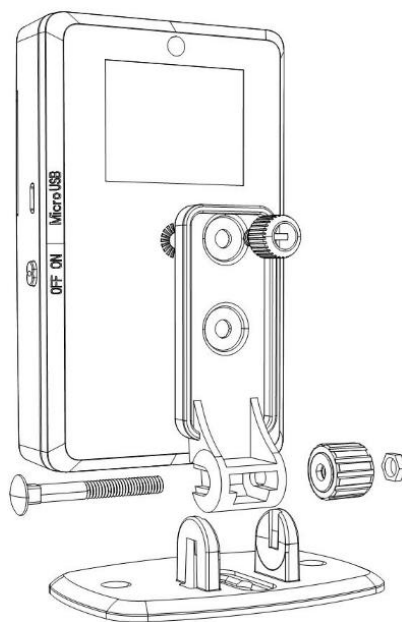

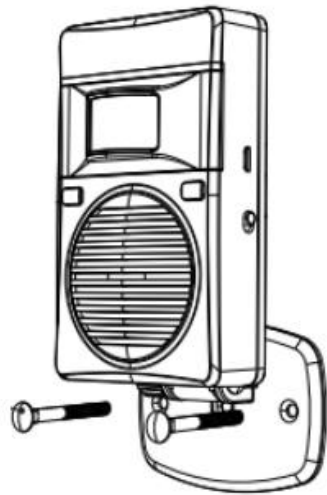

Fixed by screw

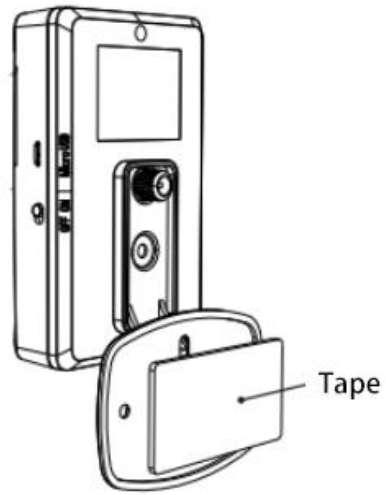

Fixed by tape

### 5.2 Installation diagram

#### ① Fixed on the door

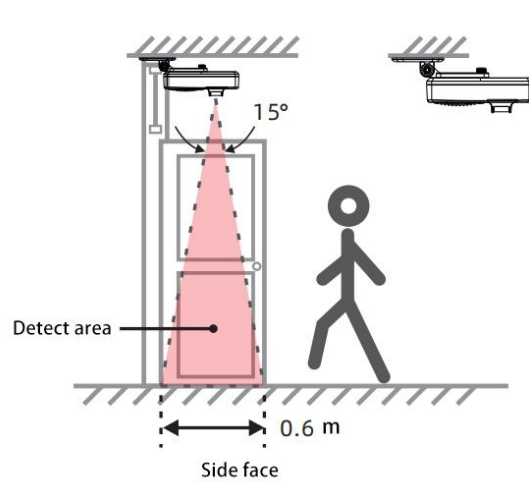
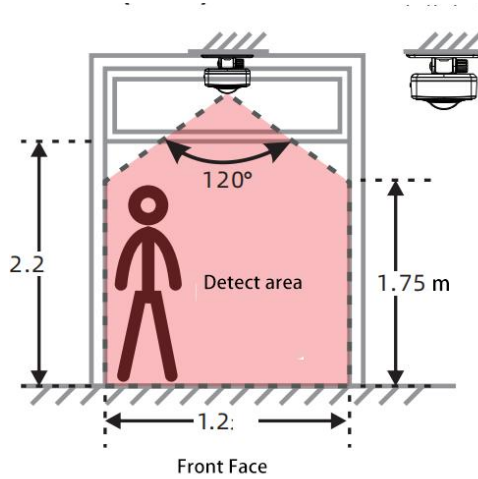

#### ② Side installation

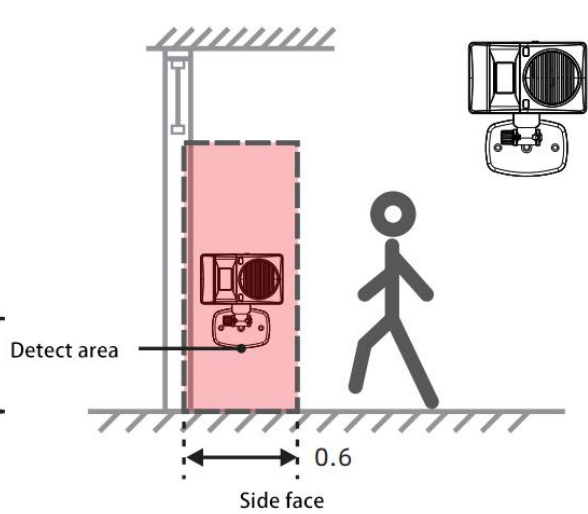
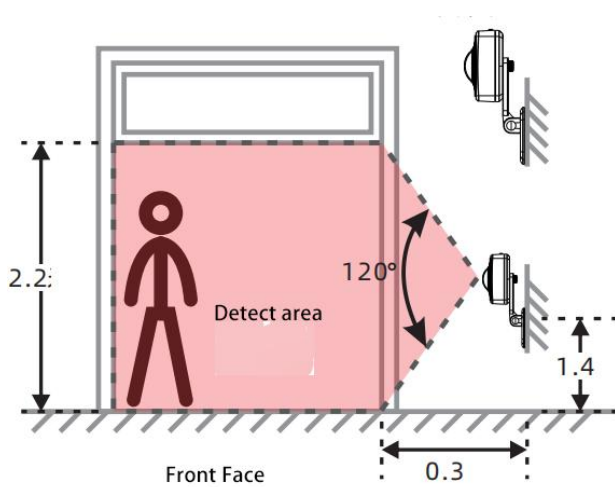

③ Aisle installation

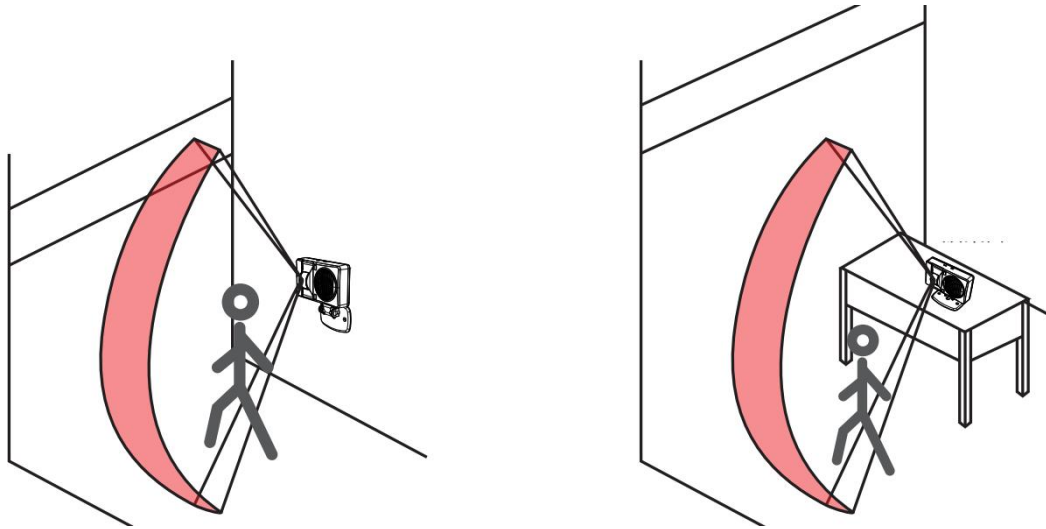

Notice:

- 1. Too high temperature ( $\geq 33^{\circ}\text{C}$ ) will affect the sensing distance and sensitivity.
- 2. The air conditioner and the fan facing the sensor head will affect the sensing distance and sensitivity.

5. Web server instruction

5.1 How to connect WiFi

- ① Use USB cable connect with the unit and computer, open the folder named "WiFi setting", entered the right WiFi name and password
- ② Installed the unit in the WiFi connected area then power on the unit, it will connect the WiFi automatically, blue LED will flash when connected successfully.

5.2 How to register an account on serve?

Enter into the website and fill in the relevant information

Link:<http://en.sound.waytronic.com/index.jsp>

WT Remote Control System

Username

Password  [Forgot password ?](#)

### 5.3 How to create group

On the “Group management” page, click "Add A Group" and fill in the group name, contact person, contact information, etc.

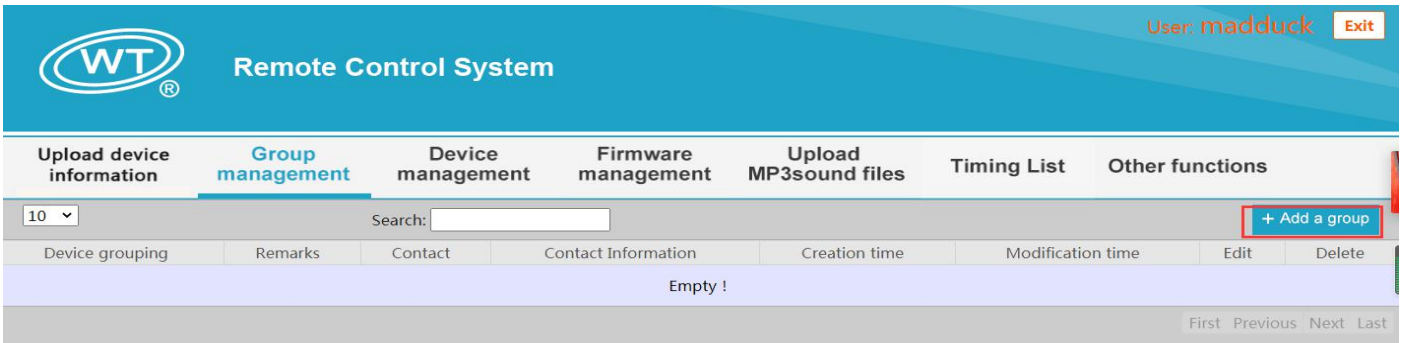

Step 1

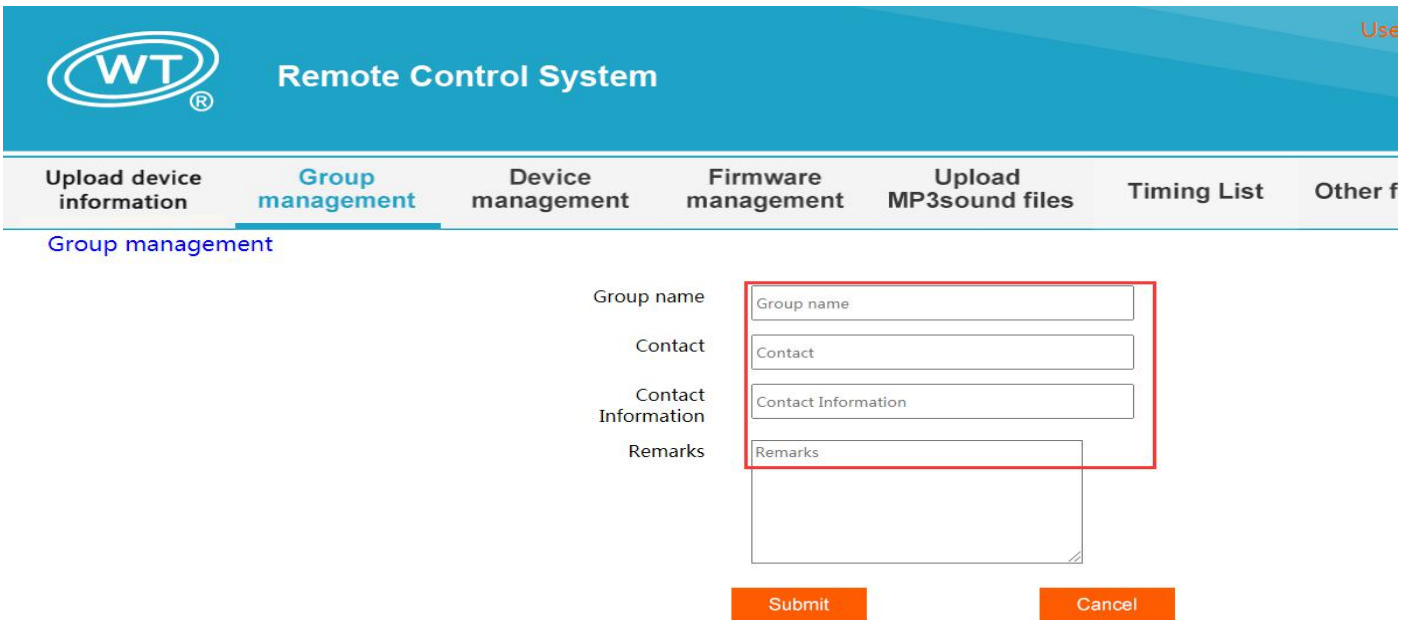

Step 2

### 5.4 How to connect with the unit

- ① Enter into the “Device management” page and click single add

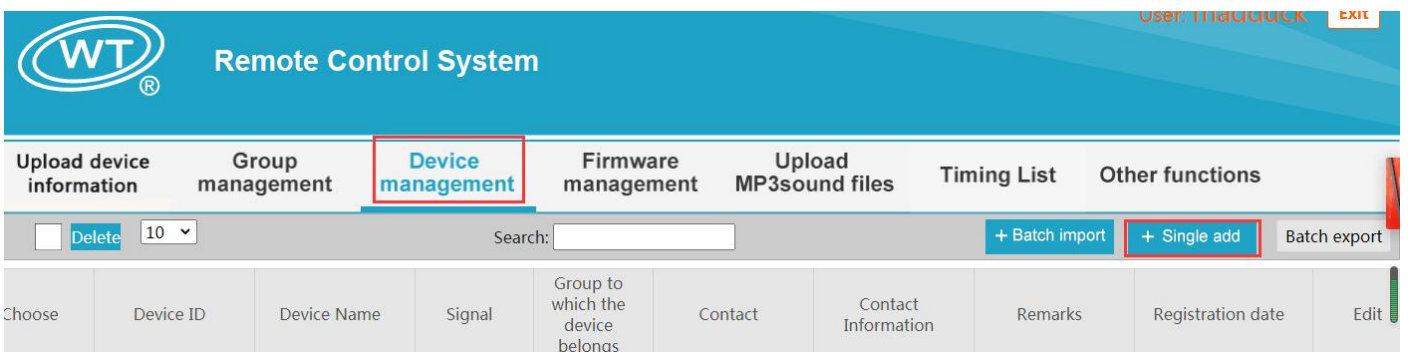

- ② Fill in the corresponding device ID (product back), device name, grouping and other information

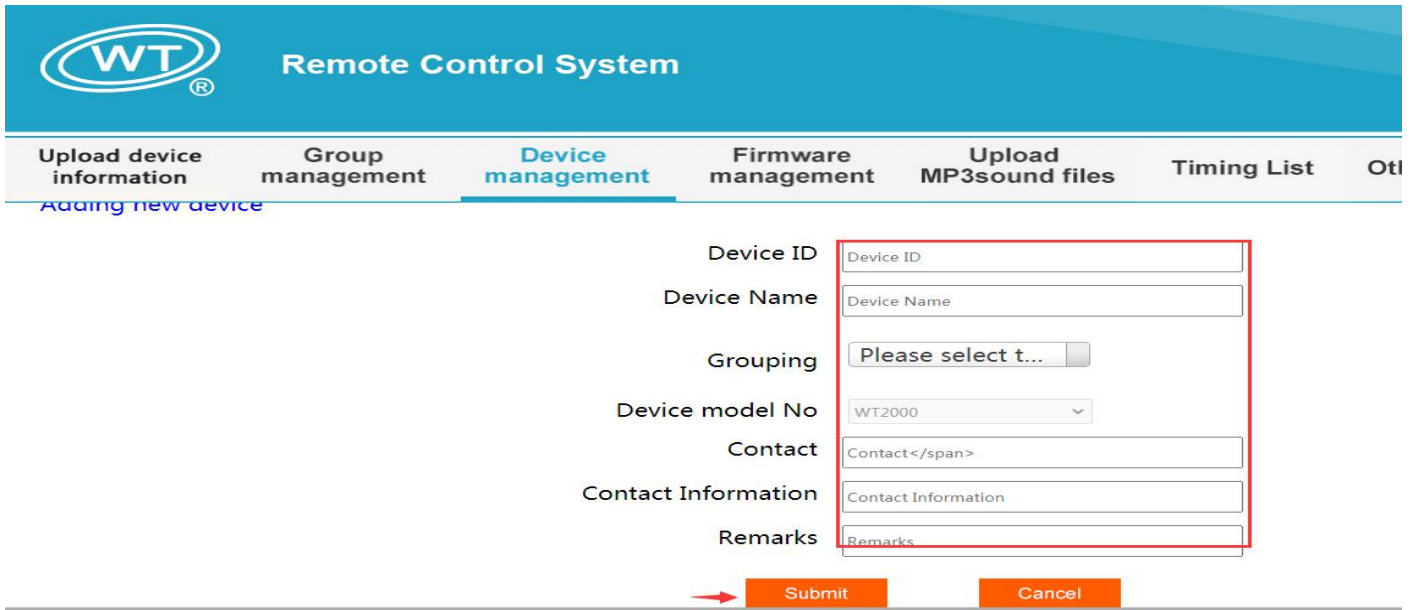

### 5.5 How to upload audio by WiFi?

① Change the name of the voice to A000-AXXX (such as A001, A002), and click "Add Audio " in " Upload MP3 Sound files" page



② First click "Add File" to select the voice then click "Start upload", latter click "Submit", which means the audio has upload to the serve.

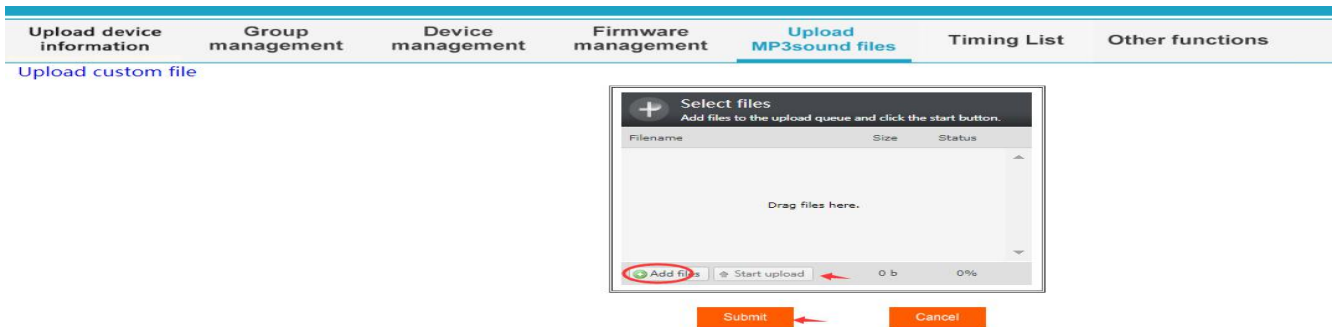

③ Click "Upload device information" to select the unit that needs to be upgraded audio, then click the "Upgrade" button and enter into the upgrade password (for example, the login password is 12345, upgrade password is 123452345, the last four words is added)

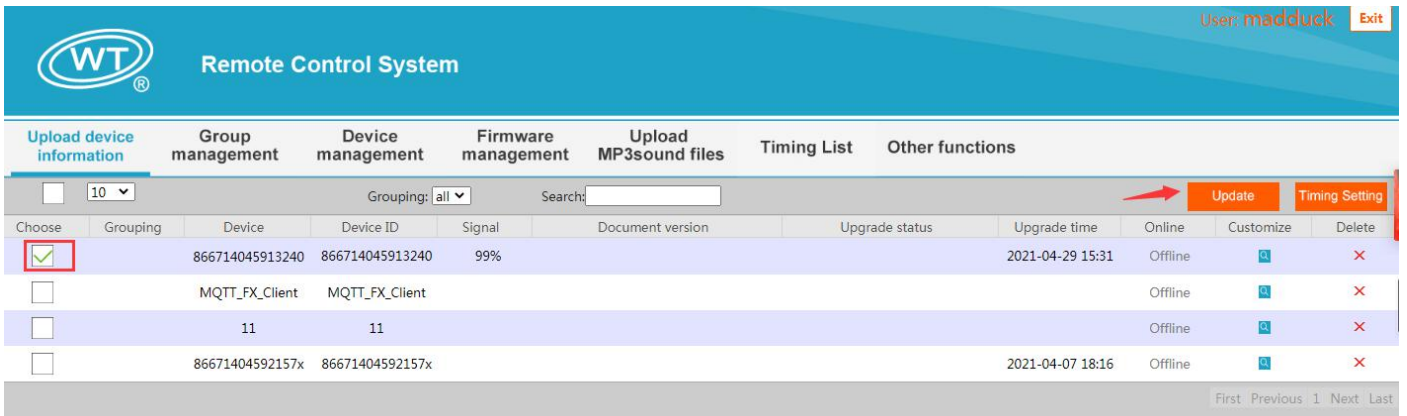

④ After entering the password, it will automatically enter to the voice selection interface, click the corresponding voice then click “upgrade”

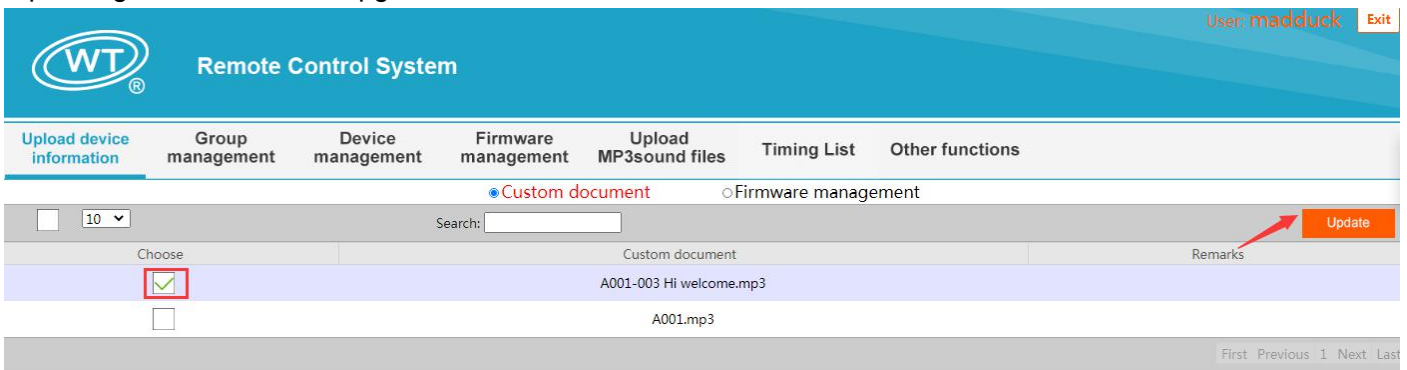

⑤ After entering the password, it will automatically enter to the voice selection interface, choose the audio and click “upgrade”

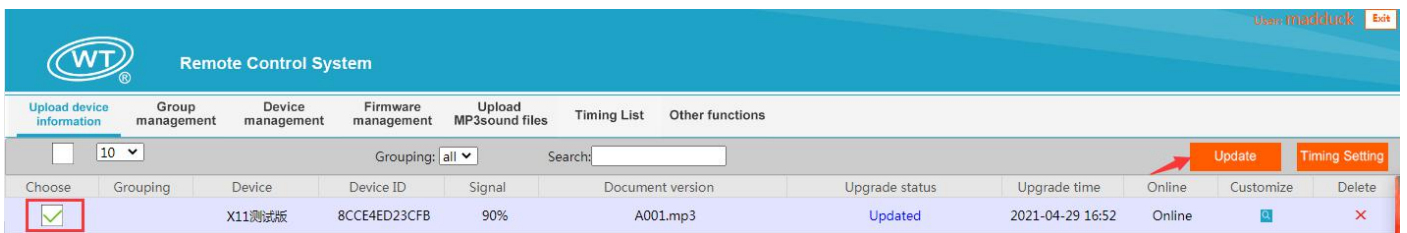

⑥ After the upgrade is completed, it will shows "updated". If there is no prompt for more than 2 minutes, please refresh the web page manually to view the results

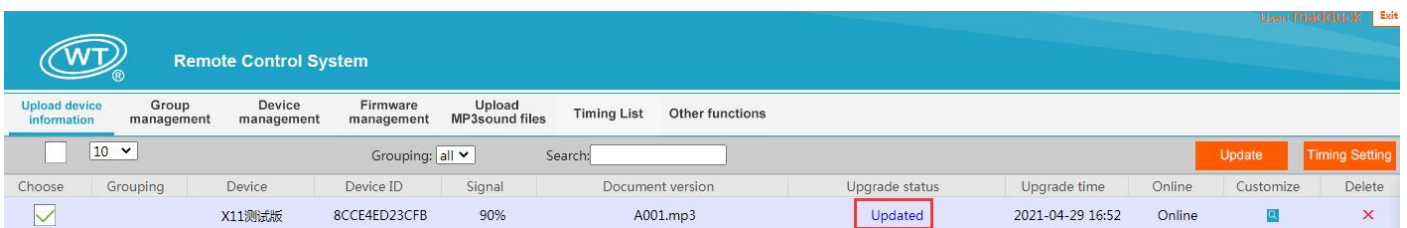

## 5.6 How to set timing play?

① Click "Device upload" to select the unit that needs to be upgraded, and then click the "timing setting" and enter the upgrade password enter into the upgrade password (for example, the login password is 12345, upgrade password is 123452345, the last four words is added)



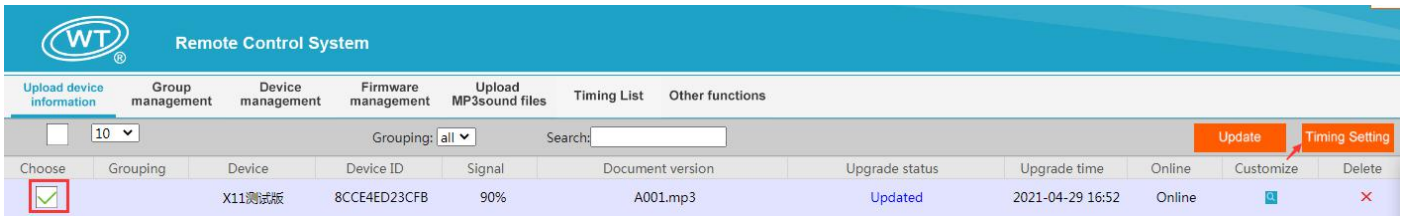

② Enter the timing page and click the "Add a group" and fill in the information like days, time, working mode, cycle interval time, audio, and volume. (The timing group can set a total of 20 groups, the interval time cannot be less than) After setting, click "Send Timing"

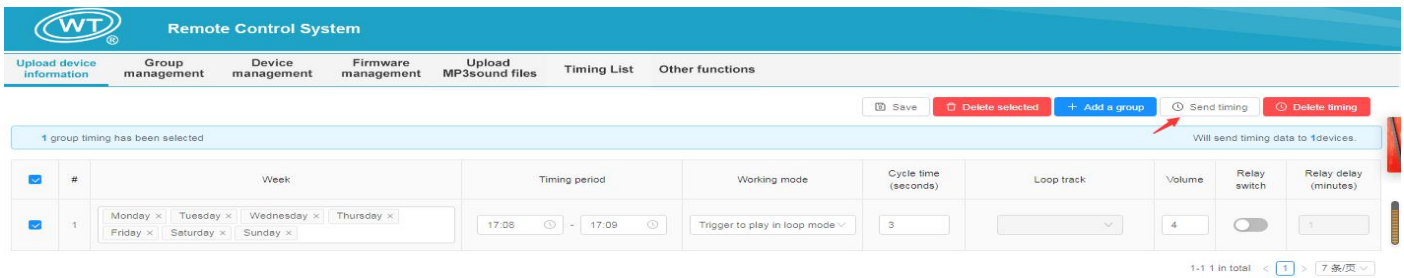

③ Delete timing group

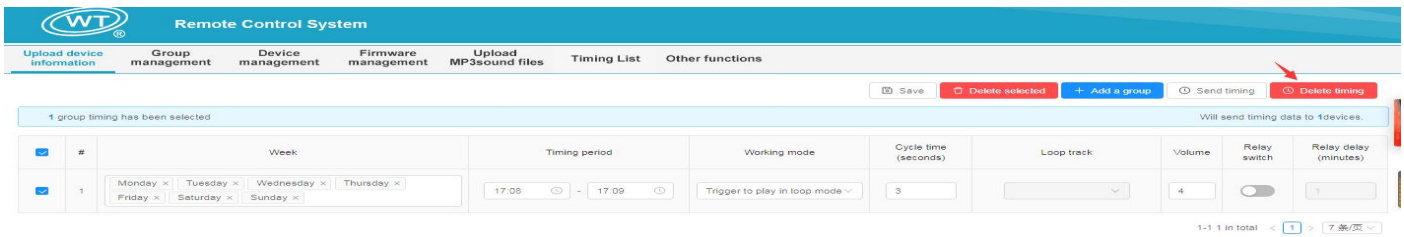

6. FAQ

Problem	Solution
Can't trigger to play voice	1. Please confirm whether the product has adjusted the sound to the minimum. 2. Please confirm whether it is within the timing range. 3. Please refresh the webpage to confirm whether the unit is being upgraded (cannot trigger playback during the upgrade)
The unit is offline	1. After installation and power on, it will be connected to the network in about 15-20 seconds, 2. Please confirm whether the IMEI number entered is correct. 3. Please refresh the webpage, then check whether the product is online.
Update 3 voices but the last one cannot be played	The audio name should be in sequence, for example, if the code is changed to A001, A002, and A004, the coded voice after A002 cannot be played during playback.
Unrecognized removable disk	1. Please confirm whether the USB cable with data transfer function. 2. Confirm whether the data line is in good contact (please try to re-plug).

## 7. Accessories

Name	Quantity
Host	1 pcs
Bracket	1 set
5V 1A USB adapter	1 pcs
USB cable	1 pcs
User manual	1 pcs

### Disclaimer

Shenzhen Waytronic Electronics Co., Ltd. reserves the right to modify the use of materials without notifying customers. The new product specifications will be subject to the latest version of the usage data.

## Contact Us

### Shenzhen Waytronic Electronics Co., Ltd.

Tel: +86-755-29605099

Fax : +86-755-29606626

Website: [en.waytronic.com](http://en.waytronic.com)

E-mail: [WT1999@waytronic.com](mailto:WT1999@waytronic.com)

Add:4/F,Building No.11,Fuan Robotics Industrial Park, Fuyong,Baoan  
District,Shenzhen ,518103,Guangdong ,China